

Article number: 20194V20V202BL

Description: E+G
T-angel clamps GN194-V20-V20-2-BL

Measures

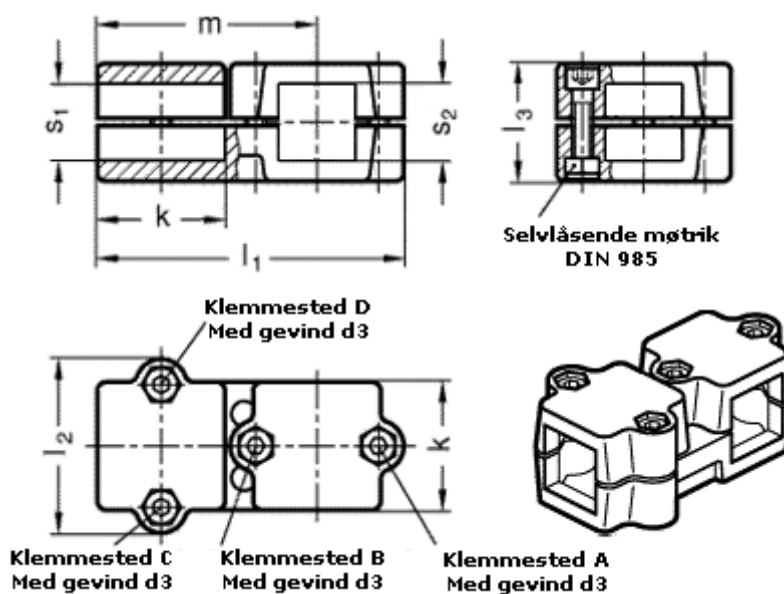

d3 = M 8

k = 50

l1 = 120

l2 = 68

l3 = 46

m = 85

s1 = 20

s2 = 20